

# Swimming Pool Heat Pump

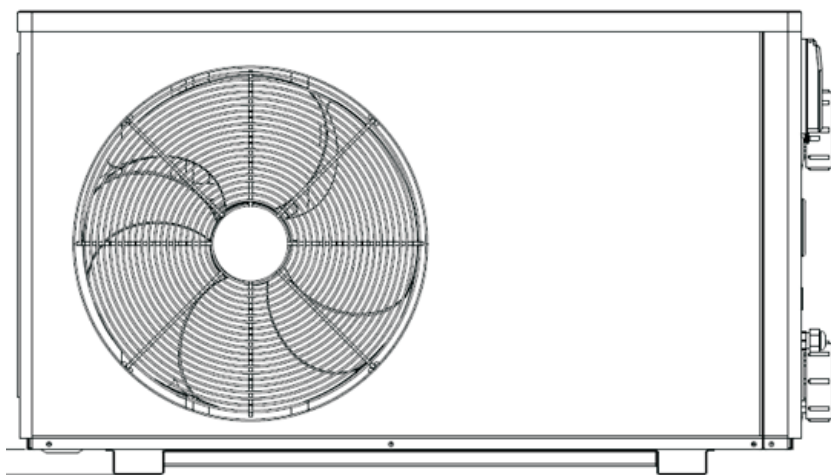

## USER MANUAL



Read the instructions

*Illustrative photo*

## Regulation (EU) n° 517/2014 of 16/04/14 on fluorinated greenhouse gases and repealing Regulation (EC) n° 842/2006

### Leak checks

1. Operators of equipment that contains fluorinated greenhouse gases in quantities of 5 tons of CO<sub>2</sub> equivalent or more and not contained in foams shall ensure that the equipment is checked for leaks.
2. For equipment that contains fluorinated greenhouse gases in quantities of 5 tons of CO<sub>2</sub> equivalent or more, but of less than 50 tons of CO<sub>2</sub> equivalent: at least every 12 months.

### Picture of the equivalence CO<sub>2</sub>

1. Load in kg and Tons amounting CO<sub>2</sub>.

Load and Tons amounting Co <sub>2</sub>	Frequency of test
From 7 at 75 kg load = from 5 at 50 Tons	Each year

**Do no release R32 coolant liquid into the atmosphere. This is a fluoride greenhouse effect gas covered by the Kyoto agreement with a global warming potential (GWP) = 675 - (see the European Community regulations on fluoride greenhouse effect gases Regulation (EU) No 517/2014).**

**Concerning the Gas R32, 7.40kg amounting at 5 tons of CO<sub>2</sub>, commitment to check each year.**

### Training and certification

1. The operator of the relevant application shall ensure that the relevant personnel have obtained the necessary certification, which implies appropriate knowledge of the applicable regulations and standards as well as the necessary competence in emission prevention and recovery of fluorinated greenhouse gases and handling safety the relevant type and size of equipment.

### Record keeping

1. Operators of equipment which is required to be checked for leaks, shall establish and maintain records for each piece of such equipment specifying the following information:
  - a) The quantity and type of fluorinated greenhouse gases installed;
  - b) The quantities of fluorinated greenhouse gases added during installation, maintenance or servicing or due to leakage;
  - c) Whether the quantities of installed fluorinated greenhouse gases have been recycled or reclaimed, including the name and address of the recycling or reclamation facility and, where applicable, the certificate number;
  - d) The quantity of fluorinated greenhouse gases recovered
  - e) The identity of the undertaking which installed, serviced, maintained and where applicable repaired or decommissioned the equipment, including, where applicable, the number of its certificate;
  - f) The dates and results of the checks carried out;
  - g) If the equipment was decommissioned, the measures taken to recover and dispose of the fluorinated greenhouse gases.
2. The operator shall keep the records for at least five years, undertakings carrying out the activities for operators shall keep copies of the records for at least five years.

# Index

1. Specifications.....	4
2. Installation .....	6
3. Initial Startup of the unit.....	10
4. Wiring diagram .....	11
5. Operation.....	13
6. Maintenance.....	18

Thank you for using BRILIX swimming pool heat pump for your pool heating it will heat your pool water and keep the constant temperature when ambient temperature at -5 to 35 °C.

In order to offer qualified, reliable and flexible heat pump unit to our customer, please read this manual carefully before installing, operating and troubleshooting, then process accordingly.

**This manual includes all necessary information.**



**ATTENTION :**

- Operating and maintaining according to recommended time and frequency on manual.
- Use only standard spare parts.

# 1. Specifications

## 1.1 Horizontal EU design, R32, HEATING AND COOLING

Models		XHPFDPLUS60	XHPFDPLUS100	XHPFDPLUS140	XHPFDPLUS160
<b>* Heating Capacity at Air 28 °C, Water 28 °C, Humidity 80%</b>					
Heating capacity	kW	5	9	12	15
Power consumption	kW	0, 8	1, 44	1, 92	2, 40
COP		6, 25	6, 25	6, 25	6, 25
<b>* Heating Capacity at Air 15 °C, Water 26 °C, Humidity 70%</b>					
Heating capacity	kW	3, 65	6, 57	9	9, 45
Power consumption	kW	0, 81	1, 46	1, 96	1, 92
COP		4, 5	4, 5	4, 6	4, 9
<b>* General data</b>					
Compressor type		Rotary/R32			
Voltage		220-240V~50Hz/1PH			
Rated Current	A	4, 5	7, 1	9, 5	9, 5
Minimum fuse	A	10	20	25	25
Advised pool volume (with pool cover)	m <sup>3</sup>	0-20	25-40	35-60	40-65
Advised water flux	m <sup>3</sup> /h	2, 5~3, 2	2, 8~5, 6	3, 5~7, 1	4~7, 9
Water Pressure Drop	Kpa	12	15	15	15
Heat exchanger		Titanium in PVC			
Water connection	mm	50			
Ventilation type		Horizontal			
Fan Speed	RPM	830~870		650	
Noise level(10m)	dB(A)	35	36	37	42
Noise level(1m)	dB(A)	44	45	46	51
Refrigerant (R32)	g	400	650	850	950
CO <sub>2</sub> equivalent	Tonne	0, 27	0, 44	0, 58	0, 64
<b>* Dimension/ Weight</b>					
Net Weight	kg	44	51	61	72
Gross Weight	kg	47	55	65	76
Net Dimension	mm	977/360/554		1047/344/621	1095/409/696
Packing Dimension	mm	1060/380/580		1120/380/660	1160/430/720

\* Above data are subjects to modification without notice.

## 1.2 Horizontal EU design, R410A , HEATING AND COOLING

Models	XHPFD40	XHPFD60	XHPFD100	XHPFD140	XHPFD160	XHPFD200	XHPFD200 Tri	
* Capacity at 25 °C/Water27 °C								
Heat Output (kW)	3, 5	5, 0	9, 0	12, 0	15, 0	18, 0	18, 0	
Power Consumption (kW)	0, 56	0, 80	1, 44	1, 92	2, 40	2, 88	2, 88	
COP	6, 25	6, 25	6, 25	6, 25	6, 25	6, 25	6, 25	
* Capacity at 15 °C/Water 27 °C								
Heat Output (kW)	2, 56	3, 65	6, 57	9, 0	9, 45	13, 50	13, 50	
Power Consumption (kW)	0, 61	0, 81	1, 46	1, 96	1, 92	2, 72	2, 72	
COP	4, 0	4, 5	4, 5	4, 6	4, 9	4, 89	4, 89	
Voltage (V)	220–240 V						380–415 V	
Rated Current (A)	3, 2	4, 5	7, 1	9, 5	9, 5	14, 2	5, 5	
Advised Fuse (A)	10, 0	10, 0	20, 0	20, 0	20, 0	35, 0	15, 0	
* Water data								
Advised pool volume (m <sup>3</sup> )	0-15	0-20	25-40	35-60	40-65	60-90	60-90	
Advised water flux (m <sup>3</sup> /h)	4, 2	4, 2	6, 0	8, 4	9, 0	10, 2	10, 2	
Water pipe in-out spec (mm)	50, 0							
* General Data								
Compressor	Rotary			Rotary	Rotary	Scroll	Scroll	
Air flow	horizontal							
Condenser	titanium in PVC							
Noise level at 10 m (dB(A))	35, 0	35, 0	36, 0	37, 0	42, 0	42, 0	42, 0	
Noise level at 1 m (dB(A))	44, 0	44, 0	45, 0	46, 0	51, 0	51, 0	51, 0	
Water pressure (kPa)	12, 0	12, 0	15, 0	15, 0	15, 0	16, 0	16, 0	
Refrigerant (kg)	0, 42	0, 45	0, 9	1, 1	1, 3	1, 7	1, 8	
*Dimension and Weight								
Net Dimension (mm)	751/300/502	935/360/545	935/360/545	1005/360/620	1045/410/695	1045/410/850	1045/410/850	
Net Weight (kg)	33	44	51	61	72	100	100	
Packing Dimension (mm)	850/330/540	1060/380/590	1060/380/590	1120/380/660	1140/430/740	1140/430/990	1140/430/990	
Gross weight (kg)	35	47	55	65	76	110	110	

Above data is subject to modification without notice.

## 2. Installation

### 2.1 Installation illustration

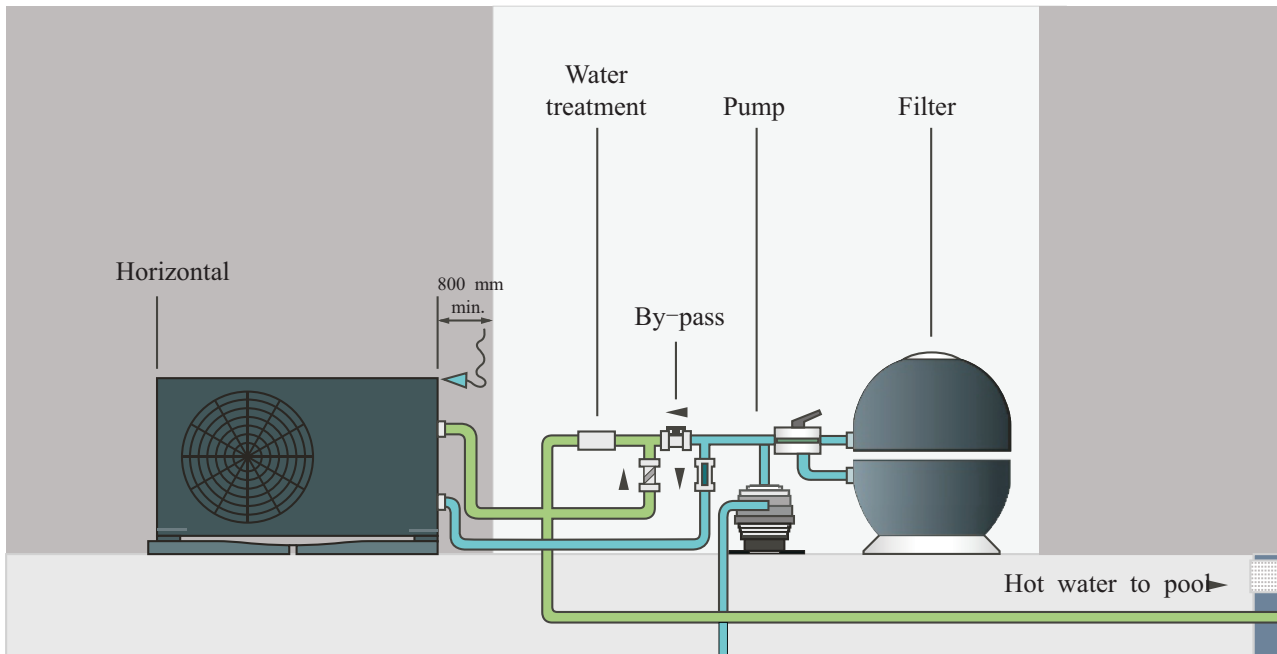

**NOTE:** The factory only provides the heat pump unit. The other items in the illustration are necessary spare parts for the water system which are provided by users or installers.



#### **ATTENTION:**

Please follow these steps when operating the first time

1. Open valve and charge water.
2. Make sure that the pump and the water-in pipe have been filled with water.
3. Close the valve and start the unit.

#### **Important NOTE:**

- Please always keep the heat pump in the ventilation place and away from anything which could cause fire.
- Don't weld the pipe if there is refrigerant inside machine. Please keep the machine out of the confined space when make gas filling.
- Action of filling gas must be conducted by professional with R32 operating license.

## 2.2 Installation

- (1) The heat pump unit must be installed by professional technicians. Otherwise unit may be damaged or body injured, even dead.
- (2) The unit designed for outdoor location with good ventilation. Recirculation of cold discharge air back into evaporator coil will greatly reduce heating capacity and efficiency of the unit, which will avoid the compressor warranty.
- (3) The unit can be installed almost anywhere in the outdoors. To get a good performance, it needs to meet the three factors:
  - a) Good ventilation
  - b) Stable and reliable power supply
  - c) Recycled water system
 The difference from gas water heater, it should not bring environmental pollution or have the installing problems in-windy areas.
- (4) The unit should not be installed in a limited air ventilation area, or placed in a bush where it will block the air inlet. These location deny the unit of a continuous source of fresh air. When seasons changing, it may stick leaves on the evaporator coil, thereby reducing its efficiency and impact of its service life.
- (5) For indoor installation, please consult more instructions from technicians.
- (6) When install a bypass, it should be not exceed 30 % of nominal flow rate
- (7) Must make Water level higher than the circulation pump location.
- (8) Below picture show the minimum required distance on each side of pool heat pump unit.

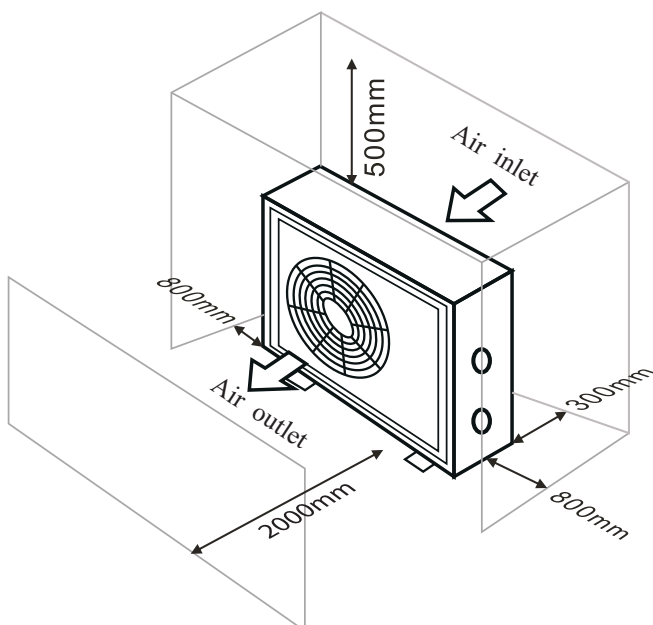

- (9) Typically, the pool heat pump unit should be installed aside the pools, less than 7.5 meters distance. If it is installed farther away, the pipeline system will cause greater heat loss. The most of pipeline are installed under ground , although the pipeline. system has to do thermal insulation ,but tunnels and the soil around will still occur heat exchange , for example, each 30 meters ( 15 meters to and from the pump=30 meters total),unless the ground is wet or the water table is high. A very rough estimate of heat loss per 30 meters is 0.6KW per hour (2000BTU) for every 5 °C surrounding the pipe, which translates to about 3% to 5% increase in run time.
- (10) To get the best heat exchange of heat pump unit, it should be matched the normal rate of water flow recommended in specification sheet.
- (11) It is required to increase the discharge pipe to prevent freezing in cold season , to put “T” fitting and ball valve to facilitate changing the water in winter or emptying the water out of system to prevent freezing when HP stop operating at the ambient temperature below zero, otherwise the unit may be damaged .
- (12) It is suggested to install the quick adaptor in front of water in-out connection, which could discharge water easily to prevent water freezing, and be convenient for maintenance and service.
- (13) When unit running , there will be some condensation water discharged from the bottom ,please hold the drainage nozzle (accessory) into the hole and clip well , and then connect a pipe to drain the condensation water out.
- (14) If water pressure is over 10 KPA , or water flow rate is more than 11 cubic meters through heat exchanger, it is necessary to install the by-pass pipe in water system.



**2.3 The location of chemical's instruction to your system is also critical to the heater's life.**

If an automatic chlorinator or brominator is used, it must be located downstream of the heater. A trap must be installed between the chlorinator and the heater to prevent chlorine return into the heat pump. (See below pictures)

**Pressure-type Chlorinator or Brominator**

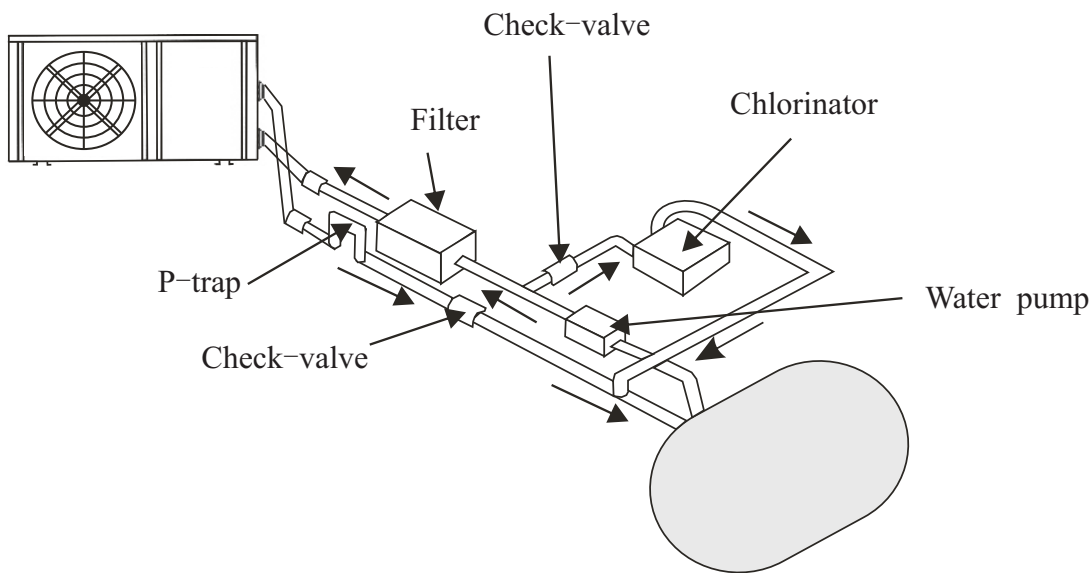

**DISCONNECT:** A disconnect means (circuit breaker, fused or un-fused switch) should be located within sight of and readily accessible from the unit. This is common practice on commercial and residential heat pumps. It prevents remotely-energizing unattended equipment and permits turning off power at the unit while the unit is being serviced.

### 3. Initial Startup of the unit

**NOTE:** Please make sure the water pump is running in circulation with adequate rate of water flow.

**Startup Procedure** after Installation is completed, and please follow these steps:

- (1) Turn on your filter pump ,check water leaks and verify flow of swimming pool.
- (2) Turn on the electrical power supply to the unit, then press the key ON/OFF of wire controller, it should start in several seconds.
- (3) After running a few minutes make sure the air ventilation from the side (top) of the unit is cooler (Between 5 °C and10 °C).
- (4) When turn off the filter pump, the unit should also turn off automatically , if not, then adjust the flow switch.
- (5) Allow the unit and pool pump to run 24 hours per day until the water reaches the desired temperature. When the temperature reaches the setting value ,the HP unit will shut down, when the pool temperature drops more than 2 °C, the heat pump will restart automatically.

#### **Water Flow Switch:**

It is equipped with a flow switch for protecting the HP unit running adequate water flow rate. It will turn on when the pool pump runs and shut it off when the pump shuts off. If the pool water level higher than 1 m above or below the heat pump's automatic adjustment knob, your dealer may need to adjust its initial startup.

#### **Time Delay:**

HP unit should be equipped with a 3-minute built-in solid-state restart delay protection. Time delay control is an integral part of the circuit control, it can eliminate restart cycling and contactor chatter. The time delay will automatically restart the HP unit approximately 3 minutes after each control circuit interruption. Even a brief power interruption will activate the solid state 3 minute restart delay and prevent the unit from the starting until the 3 minutes countdown is completed.

# 4. Wiring diagram

Model: XHPFDPLUS60 & XHPFDPLUS100

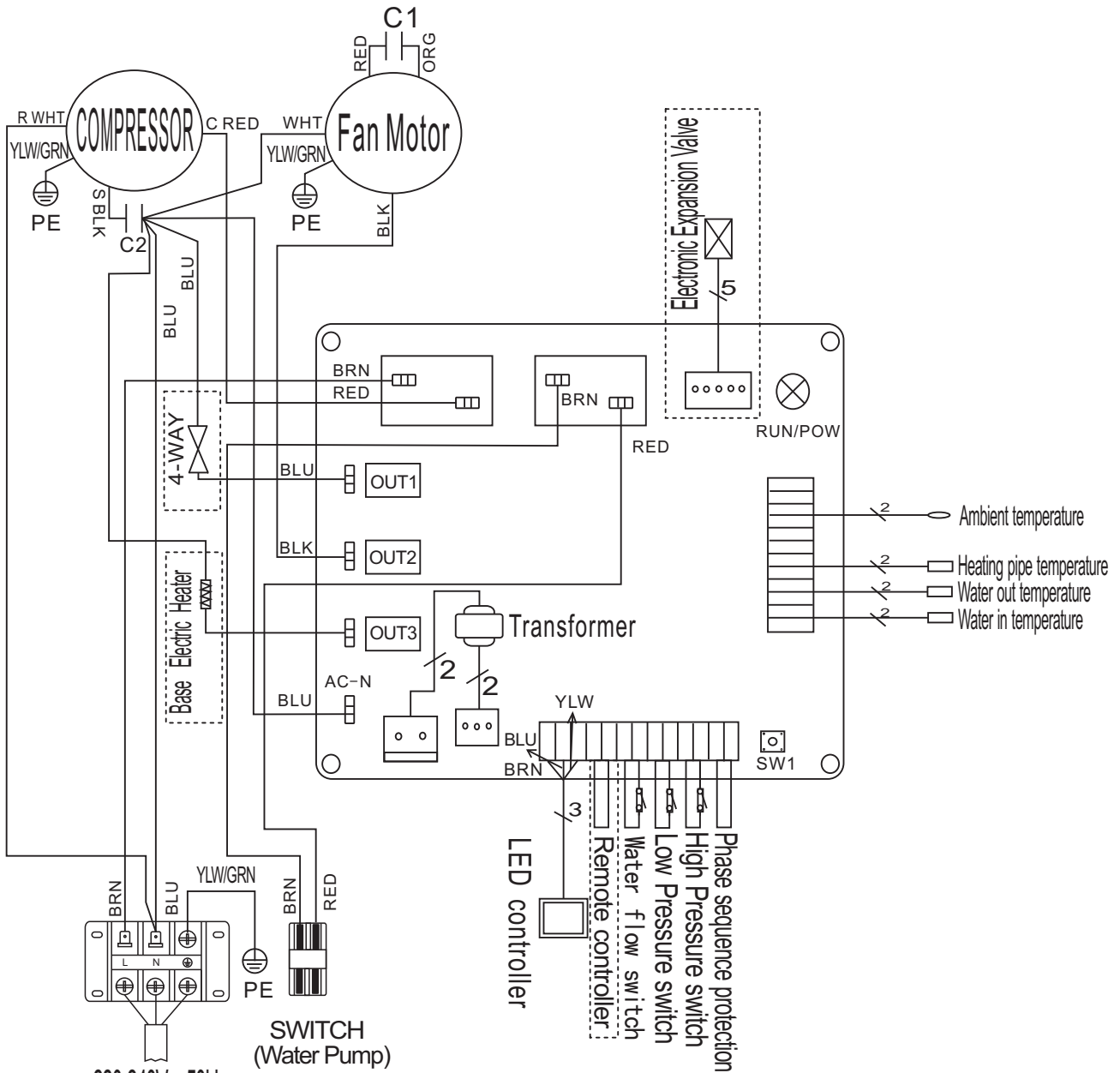

220-240V ~ 50Hz  
3-XPDLT0012S \* The dotted line part are only used in some models

**Model: XHPFDPLUS140 & XHPFDPLUS160**

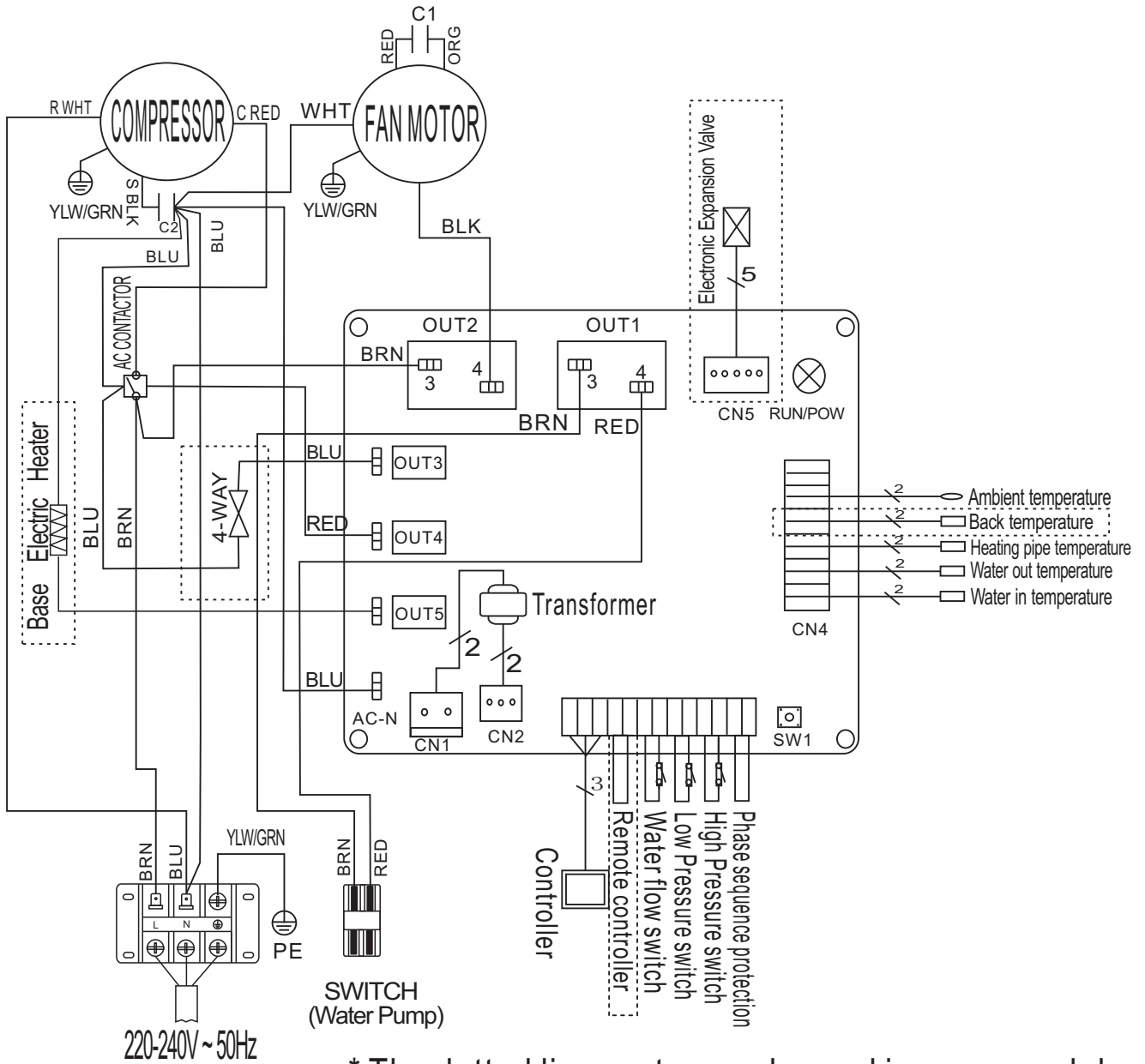

220-240V ~50Hz  
3-XPDLT0022S \* The dotted line part are only used in some models

**Note: Electrical connection**

The power supply for the heat pump must come, preferably, from an exclusive circuit with regulatory protection components (30mA differential protection) and a magneto-thermal switch.

- The electrical installation must be carried out by a specialized professional (electrician) in accordance with the standards and regulations in force in the country of installation.

- The heat pump circuit must be connected to a safety earth circuit at the terminal block.

- The cables must be properly installed to prevent interference.
- The pump is intended for connection to a general power supply with earth connection.
- Section of the cable; This section is indicative and should be checked and adapted according to the needs and conditions of use.
- The tolerance of acceptable voltage variation is +/- 10% during operation.



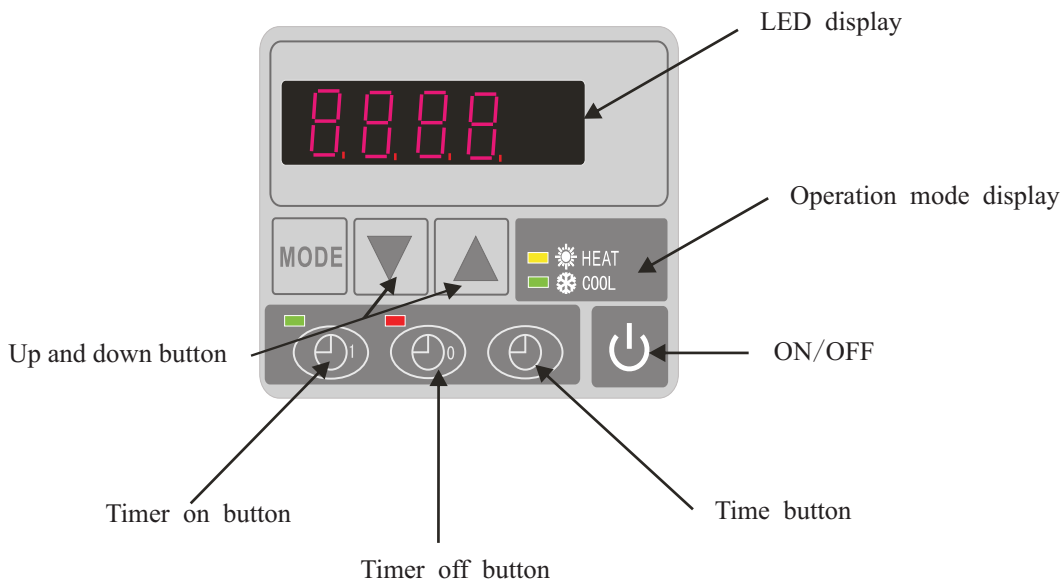

The connections must be dimensioned according to the power of the device and the state of installation.

## 5. Operation

### 5.1 The functions of LED wire controller



### 5.2 How to know operation parameter (LED display show real time till HP unit is power off)

- (1) Long press  5 seconds to enter operating parameter interface.
- (2) Under parameter interface, Press  or  to check the parameters
- (3) Leave it 8 seconds, LED will display water in temperature (under running) or time (until stops)
- (4) Under current mode, press  or  to modify the water setting temperature whenever it is ON/OFF status.
- (5) While running, the LED displays the water-in temperature and current mode

**Parameter 0**

To set the entering water temp. under cooling mode (15-35 °C, default setting: 28 °C)



**Parameter 1**

To set the entering water temp. under heating mode (15-40 °C, default setting: 28 °C)

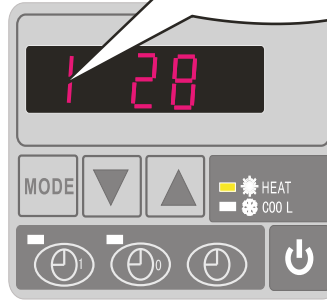

**Parameter 2**

Total working time of compressor after frosting (30-90 min, default setting : 40 min)

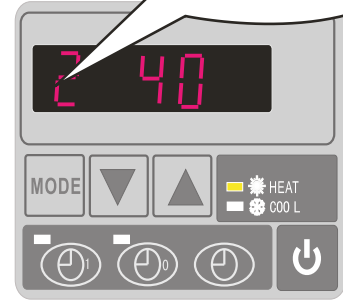

**Parameter 3**

Terms of Entry defrosting function (-30 °C to 0 °C, default setting -7 °C)

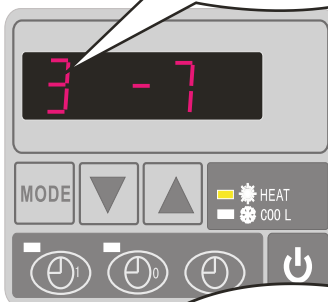

**Parameter 4**

Terms of Exit defrosting function (2 to 30 °C, default setting 20 °C)

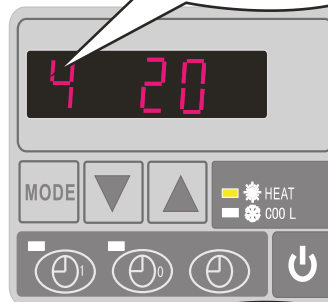

**Parameter 5**

Time of Exit defrosting (1 to 12 min, default setting 12 min)

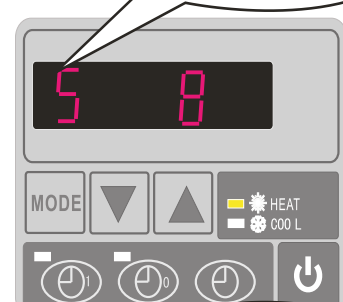

**Parameter 6**

Mode : 0 Cool 1 Heat and Cool 2 Heat and cool + auxiliary elec. Heating 3 Heat default setting: 1 Heat and Cool

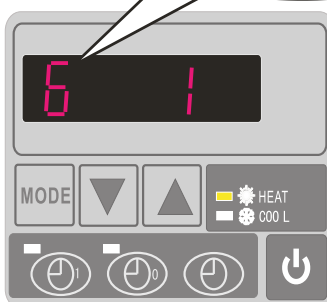

**Parameter 7**

Mode selection of Electronic expansion valve ( 0 to 1), default setting 1 (auto)

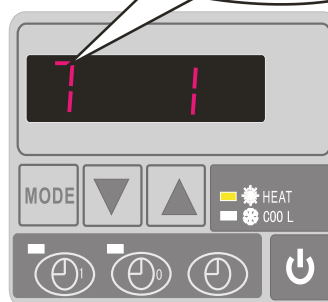

**Parameter 8**

Heating target for superheat (-15 °C-15 °C) default setting: 3 °C

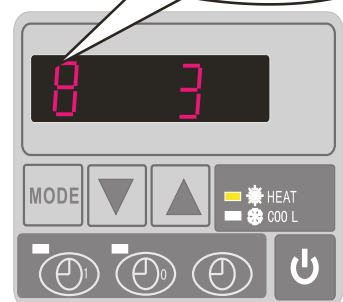

**Remarks:**

For the XHP series ,  
Mode default setting : 3. Heat

**Parameter 9**  
Manual adjustment steps of Cooling target for superheat electronic expansion valve (-15 °C -15 °C), default setting -2 °C

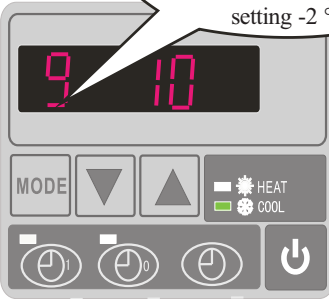

**Parameter A**  
Manual adjustment steps of electronic expansion valve (18-94), default setting: 70(\*5)

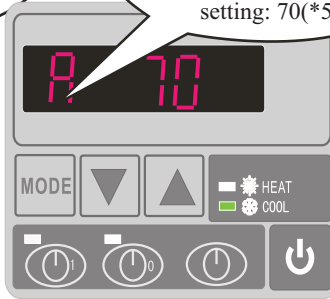

**HEATING MODE**

**COOLING MODE**

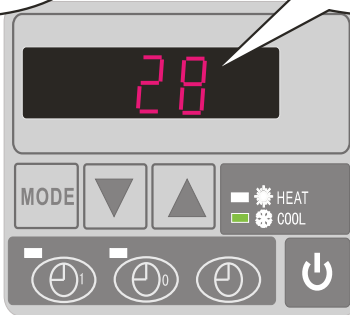

**5. 3 How to know the current status?**

**Inlet water temp.**

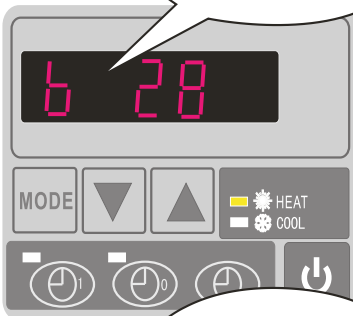

**Outlet water temp.**

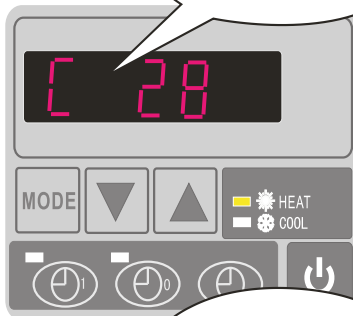

**Heating Condenser temp.**

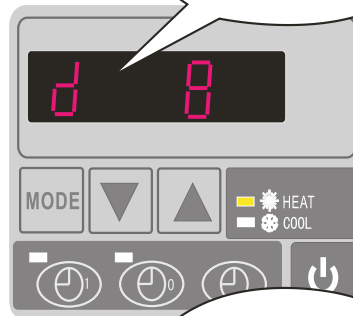

**Gas return temp.**

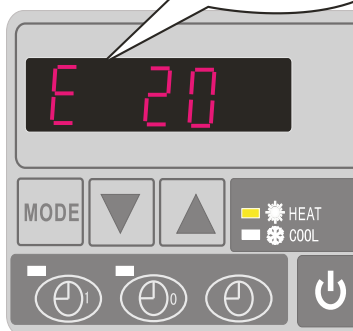

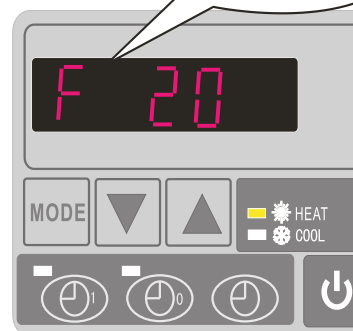

**Ambient temp.**

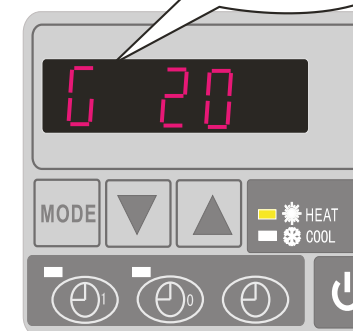

**Cooling Condenser temp.**

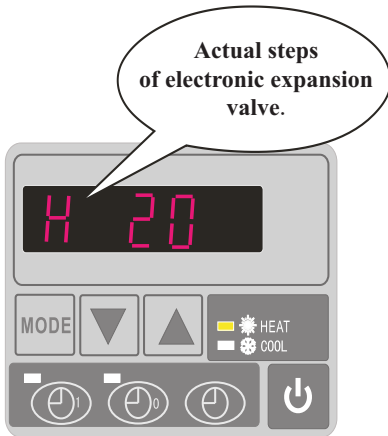



- (1) Press  or  to check water-in/water-out/heating and cooling Condenser /back gas/ambient temperature/actual steps of electronic expansion valve.
- (2) When the unit is switched off, current time is displayed.



#### 5. 4 Water temperature setting:

Under current mode, press  or  to modify the water setting temperature even if it is ON/OFF status.

#### 5. 5 Locking setting

Long press  and  5 seconds to lock the parameters, Press  and  for 5 seconds again to unlock

#### 4. 6 Time setting:

Press  to set the time, and press  or  to adjust the time After pressed the  again to store the new data.

#### 5. 7 TIMER ON SETTING

Press  to set the time for HP start to run, and press  or  to adjust starting time.then, to press  again to store the new data.

#### 5. 8 TIMER OFF SETTING

Press  to set the time for HP stop running, press  or  to adjust the time of stop running, then, press  again to store the new data. When  lights press  to cancel the timer setting.



## 5.9 RUNNING DATA SETTINGS



### ATTENTION:

- HP running parameters must be checked after installation and before first used.
- When the LED on, it will display water inlet temperature.
- When the LED off, it will display the actual time
- When the LED on, the water temp could be changed.

Parameter	Meaning	Range	Defaul	Remarks
0	To set the entering water temp under cooling mode	15 - 35 °C	28 °C	Adjustable
1	To set the entering water temp under heating mode	15 - 40 °C	28 °C	Adjustable
2	Entry into defrosting time period	30 - 90 min	40 min	
3	Terms of Entry defrosting function	-30 °C to 0 °C	-7 °C	
4	Terms of Exit defrosting function	2 to 30 °C	20 °C	
5	Time of Entry defrosting	1 to 12 min	12 min	
6	Mode: 0 Cool 1 Heat and Cool 2 Heat and Cool + auxiliary elec heating 3 Heat	0 - 3	1	For the XHP series , Mode default setting : 3. Heat
7	Mode selection of Electronic expansion valve	0 - 1	1 (auto)	
8	Superheat for heating target	-15 °C - 15 °C	3 °C	
9	Superheat for cooling target	-15 °C - 15 °C	-2 °C	
A	Manual adjustment steps of electronic expansion valve	18 - 94	70	
B	Inlet water temperature	-9 - 99 °C		Exact testing by value
C	Outlet water temperature	-9 - 99 °C		Exact testing by value
D	Condenser temperature under heating mode	-9 - 99 °C		Exact testing by value
E	Gas return temperature	-9 - 99 °C		Exact testing by value
F	Ambient temperature	-9 - 99 °C		Exact testing by value
G	Condenser temperature under Cooling mode	-		
H	Actual steps of electronic expansion valve	N * 5		Exact testing by value

**REMARKS:**

- (1) When HP stop running in 60 seconds, water pump will shut off automatically.
- (2) LED wire controller can operate the water pump after connected additional cable to the pump device in the position of “PUMP” terminal accurately.
- (3) It is necessary to put an extra 3-phase transfer device for 3 phases water pump.

## 6. Maintenance

- (1) You should check the water supply system regularly to avoid the air entering the system and occurrence of low water flow, because it would reduce the performance.
- (2) Clean your pools and filtration system regularly to avoid the damage of the unit as a result of the dirty of clogged filter.
- (3) Keep the HP unit dry, clean, well-ventilated and always clean side of the heat exchanger which can maintain a good heat exchange and energy saving.
- (4) Only a qualified service technician is allowed to operate pressure of the refrigeration system.
- (5) Check power cable connection, if heat pump start to operate abnormally, you should turn it off and contact with qualified technicians.
- (6) You should discharge the water from water pump and other water system, to prevent from the freezing damage on winter seasons.
- (7) You should discharge the water from bottom of water pump if HP unit will stop running for a lang time. In another way, you should check the units thoroughly and fill the system with water fully before the unit start to run again.

**Warranty terms and conditions**

The warranty conditions are governed by your supplier's trade and warranty terms and conditions.

**Safe disposal of the product after its service life**

After its service life is over, have the product disposed of ecologically by a specialized company.



**Claims and servicing**

Claims are governed by applicable consumer protection legislation. In the event a fault cannot be rectified, please contact your supplier in writing.

Date. ....

Supplier

